

F0-4AD2DA-1 4-Ch. IN/2-Ch. OUT ANALOG CURRENT COMBINATION



In This Chapter...

Module Specifications5-2
Setting the Module Jumper5-4
Connecting and Disconnecting the Field Wiring5-5
Wiring Diagram5-6
Module Operation5-7
Special V-memory Locations5-8
Using the Pointer in Your Control Program5-11
Scale Conversions5-13
Module Resolution5-16
Analog Input Ladder Logic Filter5-17

Module Specifications

The F0-4AD2DA-1 Analog Combination module offers the following features:

- The analog input and output channels are updated in one scan.
- The removable terminal block makes it possible to remove the module without disconnecting the field wiring.
- Analog inputs can be used as process variables for the four (4) PID loops in the DL05 and the eight (8) PID loops in the DL06 CPUs.
- On-board active analog filtering and RISC-like microcontroller provide digital signal processing to maintain precise analog measurements in noisy environments.

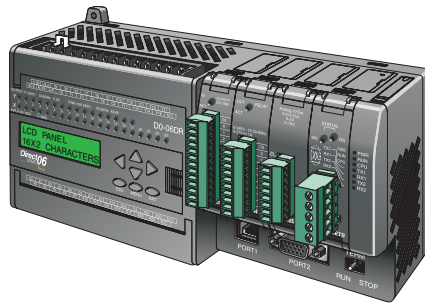
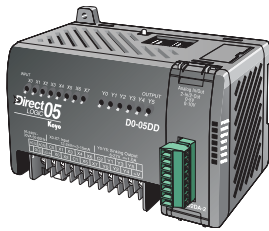

NOTE: The DL05 CPU's analog feature for this module requires **DirectSOFT32** Version 3.0c (or later) and firmware version 3.30 (or later). The DL06 requires **DirectSOFT32** version V4.0, build 16 (or later) and firmware version 1.00 (or later). See our website for more information: www.automationdirect.com.

The following tables provide the specifications for the F0-4AD2DA-1 Analog Combination Module. Review these specifications to make sure the module meets your application requirements.

Input Specifications	
Number of Channels	4, single ended (one common)
Input Range	0 to 20 mA or 4 to 20 mA (jumper selectable)
Resolution	12 bit (1 in 4096) for 0-20mA, scaled for 4-20mA
Step Response	25.0 mS (typ) to 95% of full step change
Crosstalk	-80 dB, 1/2 count maximum *
Active Low-pass Filtering	-3 dB at 40Hz (-12 dB per octave)
Input Impedance	125 Ohm \pm 0.1%, 1/8 W current input
Absolute Maximum Ratings	-30 mA to +30 mA current input
Converter type	Successive approximation
Linearity Error (End to End)	\pm 2 counts
Input Stability	\pm 1 count *
Full Scale Calibration Error (Offset error not included)	\pm 10 counts maximum @ 20mA current input*
Offset Calibration Error	\pm 5 counts maximum @ 0mA current input *
Maximum Inaccuracy	\pm .4% @ 25°C (77°F) \pm .85% 0 to 60°C (32 to 140°F)
Accuracy vs. Temperature	\pm 100 ppm typical full scale calibration (including maximum offset change)
Recommended Fuse (external)	0.032 A Series 217 fast-acting, current inputs

*One count in the specification table is equal to one least significant bit of the analog data value (1 in 4096).

Output Specifications	
Number of Channels	2, single ended (one common)
Output Range	4 to 20 mA or 0 to 20 mA (jumper selectable)
Output Type	Current sourcing
Resolution	12 bit (1 in 4096) for 0 to 20 mA, scaled for 4 to 20 mA
Maximum Loop Voltage	30 VDC
Load (ohms)/Loop Power Supply	0-300/18-30V
Linearity Error (end to end)	\pm 2 counts (\pm 0.050% of full scale) maximum *
Conversion Settling Time	400 μ S max. full scale change
Full Scale Calibration Error	\pm 26 counts max. @ 300 Ω load \pm 18 counts max. @ 250 Ω load \pm 12 counts max. @ 125 Ω load
Note: Error depends on the load from source terminal to ground.	
Offset Calibration Error	\pm 10 counts max. @ 300 Ω load \pm 8 counts max @ 250 Ω load \pm 6 counts max. @ 125 Ω load
Max. Full Scale Inaccuracy (% of full scale) all errors included	300 Ω load 0.4% @ 60°C 250 Ω load 0.3% @ 60°C 125 Ω load 0.2% @ 60°C

* One count in the specification tables is equal to one least significant bit of the analog data value (1 in 4096).

General Specifications	
PLC Update Rate	4 input channels per scan, 2 output channels per scan
16-bit Data Word	12 binary data bits
Operating Temperature	0 to 60°C (32 to 140°F)
Storage Temperature	-20 to 70°C (-4 to 158°F)
Relative Humidity	5 to 95% (non-condensing)
Environmental Air	No corrosive gases permitted
Vibration	MIL STD 810C 514.2
Shock	MIL STD 810C 516.2
Noise Immunity	NEMA ICS3-304
Power Budget Requirement	100 mA @ 5VDC (supplied by base)
Connector	Phoenix Mecano, Inc., Part No. AK1550/8-3.5 - green
Connector Wire Size	28 - 16 AWG
Connector Screw Torque	0.4 Nm
Connector Screwdriver Size	DN-SS1 (recommended)

5

Setting the Module Jumper

The position of the J2 jumper determines the input and output signal level. You can choose between 0–20mA and 4–20mA signal levels. The module ships without the jumper connecting the pins (pins not jumpered). In this position, the input and output signal level is 4–20mA. To select 0–20mA signal level, install the jumper, connecting the pins.

The J2 jumper is shown in the 4–20mA position (not installed). Install the jumper for the 0–20mA position.

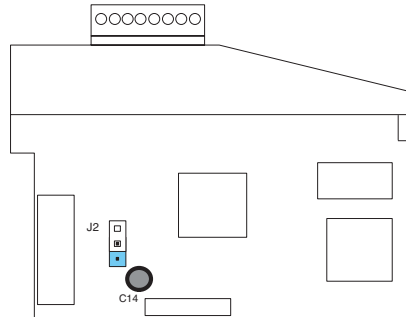

WARNING: Before removing the analog module or the terminal block on the face of the module, disconnect power to the PLC and all field devices. Failure to disconnect power can result in damage to the PLC and/or field devices.

Connecting and Disconnecting the Field Wiring

Wiring Guidelines

Your company may have guidelines for wiring and cable installation. If so, you should check those before you begin the installation. Here are some general things to consider:

- Use the shortest wiring route whenever possible.
- Use shielded wiring and ground the shield at the transmitter source. Do not ground the shield at both the module and the source.
- Do not run the signal wiring next to large motors, high current switches, or transformers. This may cause noise problems.
- Route the wiring through an approved cable housing to minimize the risk of accidental damage. Check local and national codes to choose the correct method for your application.

A separate transmitter power supply may be required, depending on the type of transmitter being used.

This module has a removable connector to make wiring and module removal easier. To remove the terminal block, disconnect power to the PLC and the field devices. Pull the terminal block firmly until the connector separates from the module.

The analog module can be removed from the PLC by folding out the retaining tabs at the top and bottom of the module. As the retaining tabs pivot upward and outward, the module's connector is lifted out of the PLC socket. Once the connector is free, you can lift the module out of its slot.

Wiring Diagram

Use the following diagram to connect the field wiring. If necessary, the terminal block can be removed to make removal of the module possible without disturbing field wiring.

Typical User Wiring

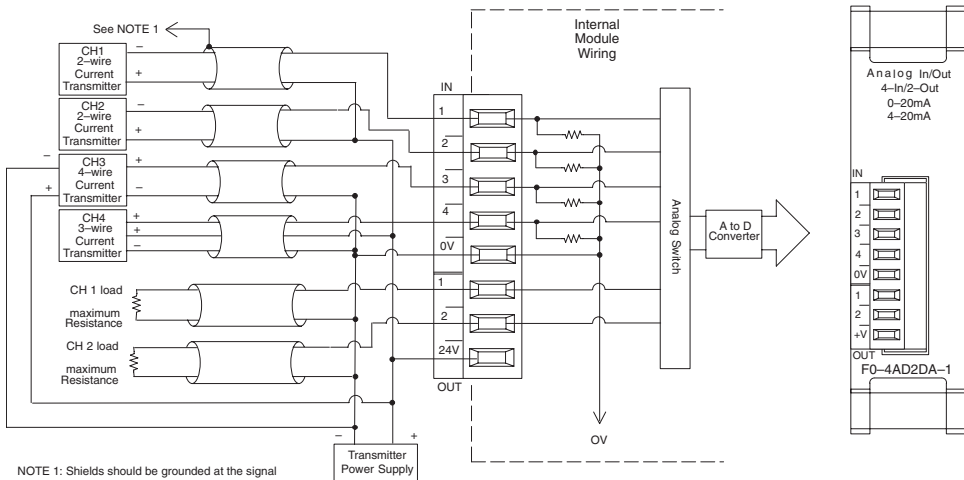

NOTE 1: Shields should be grounded at the signal source.
 NOTE 2: Connect all external power supply commons.

5

Module Operation

Input/Output Channel Update Sequence

The DL05 and DL06 will read four channels of input data and two channels of output data during each scan. Each CPU supports special V-memory locations that are used to manage the data transfer. This is discussed in more detail beginning on the next page, “Special V-memory Locations”.

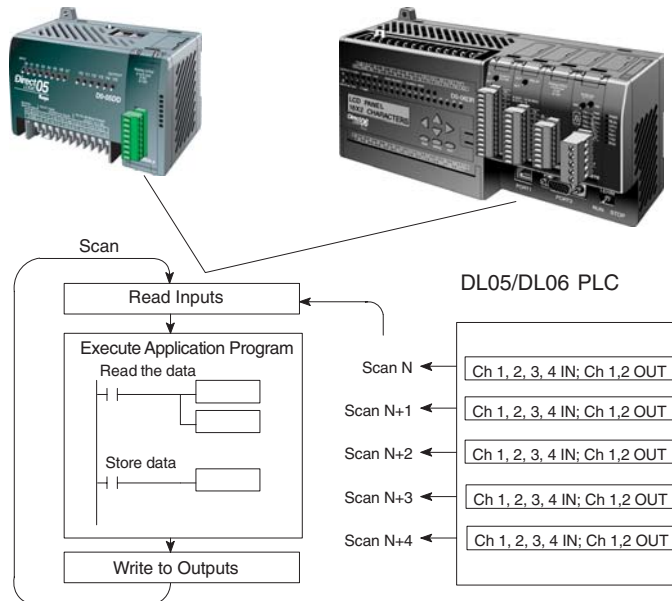

Analog Module Updates

Even though the channel updates to the CPU are synchronous with the CPU scan, the module asynchronously monitors the analog transmitter signals and converts each signal into a 12-bit binary representation. This enables the module to continuously provide accurate measurements without slowing down the discrete control logic in the RLL program.

The module takes approximately 25 milliseconds to sense 95% of the change in the analog signal. For the vast majority of applications, the process changes are much slower than these updates.



NOTE: If you are comparing other manufacturers' update times (step responses) with ours, please be aware that some manufacturers refer to the time it takes to convert the analog signal to a digital value. Our analog to digital conversion takes only a few microseconds. It is the settling time of the filter that is critical in determining the full update time. Our update time specification includes the filter settling time.

Special V-memory Locations

Formatting the Module Data

The DL05 and DL06 PLCs have three special V-memory locations assigned to their respective option slots. These V-memory locations allow you to:

- specify the data format (binary or BCD)
- specify the number of input and output channels to scan.
- specify the V-memory locations to store the input data
- specify the V-memory locations to store the output data

DL05 Data Formatting

The table below shows the special V-memory locations used by the DL05 PLC for the analog combination module.

Analog Combination Module DL05 Special V-memory Locations	
Data Type and Number of I/O Channels	V7700
Input Storage Pointer	V7701
Output Storage Pointer	V7702

Structure of V7700

V-memory location 7700 is used for identifying the number of output channels, the number of input channels and the data type (binary or BCD). The low byte equals the number of output channels and the high byte equals the number of input channels. Enter a 1 through 4 to select the number of input channels and a 1 through 2 to select the number of output channels to be used. A zero (0) entered for channel selection will cause the channel, either input or output, to be inoperative.

Loading a constant of 402 into V7700 identifies four input and two output analog channels, and sets the I/O data type to BCD.

Loading a constant of 8482 into V7700 identifies four input and two output analog channels, and sets the I/O data type to binary.

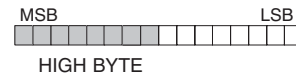

Structure of V7701

V7701 is a system parameter that points to a V-memory location used for storing analog input data. The V-memory location loaded in V7701 is an octal number identifying the first V-memory location for the analog input data. This V-memory location is user selectable. For example, loading O2000 causes the pointer to write Ch 1's data value to V2000, Ch 2's data value to V2001, CH 3's data value to V2002 and Ch 4's data value to V2003.

Structure of V7702

V7702 is a system parameter that points to a V-memory location used for storing analog output data. The V-memory location loaded in V7702 is an octal number identifying the first V-memory location for the analog output data. This V-memory location is user selectable. For example, loading O2010 causes the pointer to read Ch 1's data value at V2010 and Ch 2's data value at V2011.

You will find an example program that loads appropriate values to V7700, V7701 and V7702 on page 5-11.

DL06 Data Formatting

Special V-memory locations are assigned to the four option module slots of the DL06 PLC. The table below shows these V-memory locations which can be used by the F0-4AD2DA-1.

Analog Combination Module DL06 Special V-memory Locations				
Slot No.	1	2	3	4
Data Type and Number of Channels	V700	V710	V720	V730
Input Storage Pointer	V701	V711	V721	V731
Output Storage Pointer	V702	V712	V722	V732

Setup Data Type and Number of Channels

V-memory locations 700, 710, 720 and 730 are used to set the number of output channels, the number of input channels and the data type (binary or BCD). The low byte equals the number of output channels and the high byte equals the number of input channels. Enter a 1 through 4 to select the number of input channels and a 1 through 2 to select the number of output channels to be used. A zero (0) entered for channel selection will cause the channel, either input or output, to be inoperative.

Consider the F0-4AD2DA-1 to be installed in slot 2. Loading a constant of 402 into V710 identifies four input and two output analog channels, and sets the I/O data type to BCD.

Loading a constant of 8482 into V710 identifies four input and two output analog channels, and sets the I/O data type to binary.

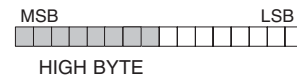
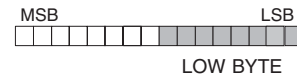

Input Storage Pointer Setup

V-memory locations 701, 711, 721 and 731 are special locations used as a storage pointer for the analog input data. With the analog module installed in slot 2, the V-memory location loaded in V711 is an octal number identifying the first user V-memory location to write the analog input data to. This V-memory location is userselectable. For example, loading O2000 causes the pointer to write Ch 1's data value to V2000, Ch 2's data value to V2001, CH 3's data value to V2002 and Ch 4's data value to V2003.

Output Storage Pointer Setup

V-memory locations 702, 712, 722 and 732 are special locations used as a storage pointer for the analog output data. With the analog module installed in slot 2, the V-memory location loaded in V712 is an octal number identifying the first user V-memory location to read the analog output data from. This V-memory location is user selectable. For example, loading O2010 causes the pointer to read Ch 1's data value at V2010 and Ch 2's data value at V2011.

You will find an example program that loads appropriate values to V710, V711 and V712 on page 5-12.

Using the Pointer in Your Control Program

DL05 Pointer Method

The DL05 CPU examines the pointer values (the memory locations identified in V7700, V7701 and V7702) on the first scan only.

The example program below shows how to setup these locations for 4 input channels and 2 output channels. This rung can be placed anywhere in the ladder program or in the initial stage if you are using stage programming instructions.

This is all that is required to read the analog input and output data into V-memory locations. Once the data is in V-memory you can perform math on the data, compare the data against preset values, and so forth. V2000 and V2010 are used in the example, the V-memory locations are user selectable.

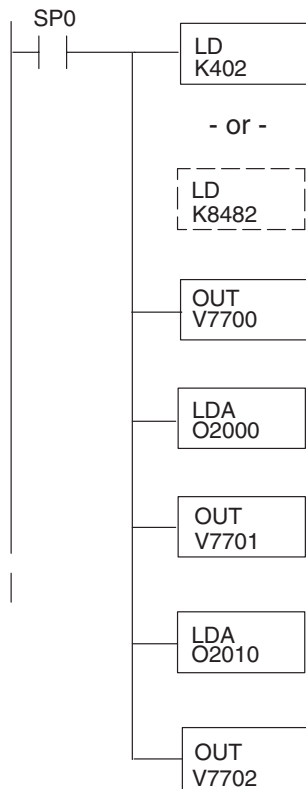

Loads a constant that specifies the number of channels to scan and the data format. The upper byte selects the input data format (i.e. 0=BCD, 8=Binary) and the number of input channels (set to 4). The lower byte selects the output data format (i.e. 0=BCD, 8=Binary) and the number of output channels (set to 2).

The binary format is used for displaying data on some operator interface units. The DL05 PLCs support binary math functions.

Special V-memory location assigned to the option slot contains the data format and the number of channels to scan.

This loads an octal value for the first V-memory location that will be used to store the incoming data. For example, the O2000 entered here would designate the following addresses:

Ch1 – V2000, Ch2 – V2001, Ch3 – V2002, Ch4 – V2003

The octal address (O2000) is stored here. V7701 is assigned to the option slot and acts as a pointer, which means the CPU will use the octal value in this location to determine exactly where to store the incoming data.

This loads an octal value for the first V-memory location that will be used to store the output data. For example, the O2010 entered here would designate the following addresses:

Ch1 – V2010, Ch2 – V2011

The octal address (O2010) is stored here. V7702 is assigned to the option slot and acts as a pointer, which means the CPU will use the octal value in this location to determine exactly where to get the output data.

DL06 Pointer Method

Use the special V-memory table as a guide to setup the pointer values in the following example for the DL06. Slot 1 is the left most option slot. The CPU will examine the pointer values at these locations only after a mode transition, first scan only.

Analog Combination Module DL06 Special V-memory Locations				
Slot No.	1	2	3	4
No. of Channels	V700	V710	V720	V730
Input Pointer	V701	V711	V721	V731
Output Pointer	V702	V712	V722	V732

The F0-4AD2DA-1 can be installed in any available DL06 option slot. Using the example program from the previous page, but changing the V-memory addresses, the ladder diagram below shows how to setup these locations for 4 input channels and 2 output channels with the module installed in slot1 of the DL06. Use the above table to determine the pointer values if locating the module in any of the other slot locations. Place this rung anywhere in the ladder program or in the initial stage if you are using stage programming instructions.

Like the DL05 example, this logic is all that is required to read the analog input data into V-memory locations. Once the data is in V-memory you can perform mathematical calculations with the data, compare the data against preset values, and so forth. V2000 and V2010 is used in the example but you can use any user V-memory location.

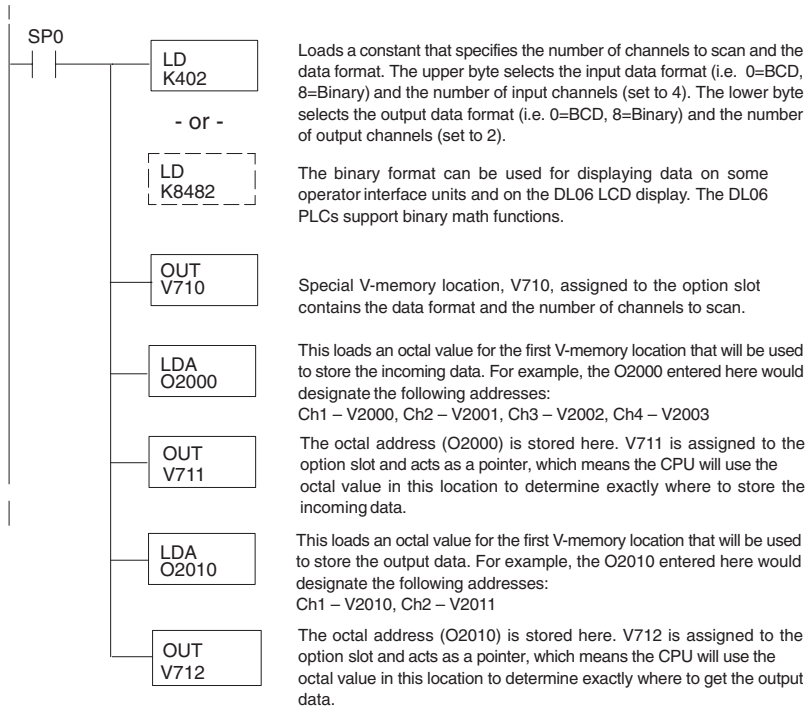

Scale Conversions

Scaling the Input Data

Many applications call for measurements in engineering units, which can be more meaningful than raw data. Convert to engineering units using the formula shown to the right.

You may have to make adjustments to the formula depending on the scale you choose for the engineering units.

$$\text{Units} = A \frac{H-L}{4095} + L$$

H = High limit of the engineering unit range

L = Low limit of the engineering unit range

A = Analog value (0 – 4095)

For example, if you wanted to measure pressure (PSI) from 0.0 to 100.0 then you would have to multiply the analog value by 10 in order to imply a decimal place when you view the value with the programming software or a handheld programmer. Notice how the calculations differ when you use the multiplier.

Analog Value of 2024, slightly less than half scale, should yield 49.4 PSI

Example without multiplier

$$\text{Units} = A \frac{H-L}{4095} + L$$

$$\text{Units} = 2024 \frac{100-0}{4095} + 0$$

$$\text{Units} = 49$$

Handheld Display

V 2001	V 2000
0000	0049

Example with multiplier

$$\text{Units} = 10 A \frac{H-L}{4095} + L$$

$$\text{Units} = 20240 \frac{100-0}{4095} + 0$$

$$\text{Units} = 494$$

Handheld Display

V 2001	V 2000
0000	0494

This value is more accurate

The Conversion Program

The following example shows how you would write the program to perform the engineering unit conversion from input data formats 0–4095. This example assumes the raw input data read at V2000 is in BCD format.

Note: this example uses SP1, which is always on. You could also use an X, C, etc. permissive contact.

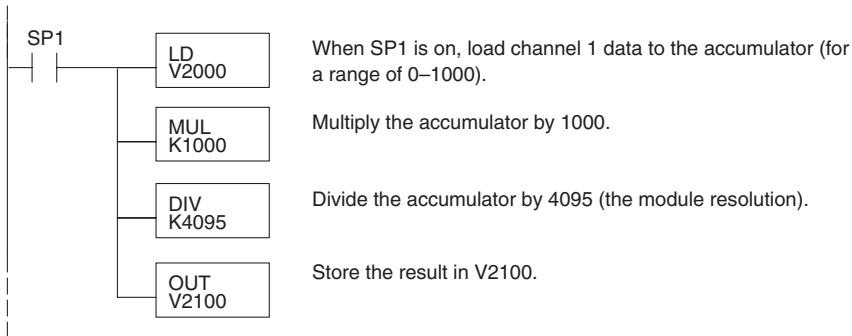

Output Conversion Program

The following example program shows how you would write the program to perform the engineering unit conversion to output data formats 0–4095. This example assumes you have calculated or loaded the engineering unit values between 0–1000 in BCD format and stored them in V2300 and V2301 for channels 1 and 2 respectively. Both the DL05 and DL06 offer instructions that allow you to perform math operations using BCD format. It is usually easier to perform any math calculations in BCD and then convert the value to binary before you send the data to the module.

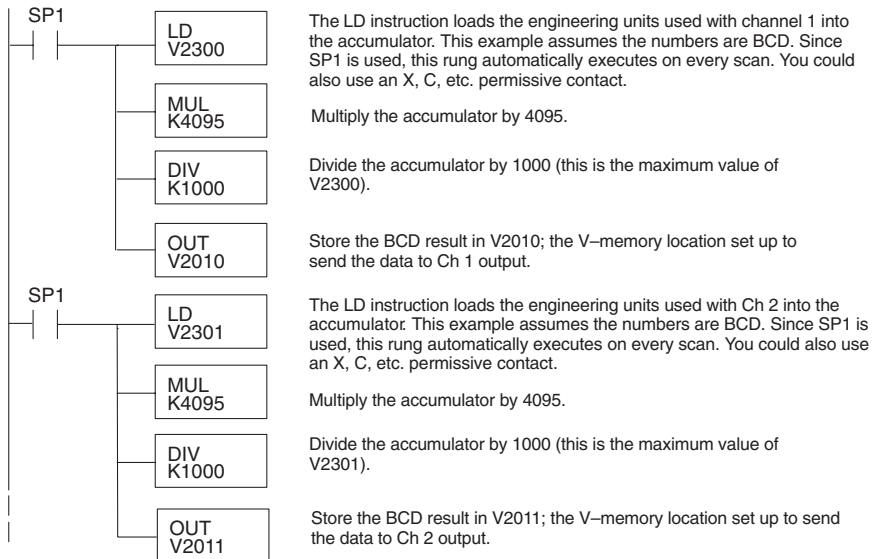

Analog and Digital Value Conversions

Sometimes it is useful to convert between the signal levels and the digital values. This is especially helpful during machine startup or troubleshooting. The following tables provide formulas to make this conversion easier.

Range	If you know the digital value	If you know the analog signal level
4 to 20mA	$A = \frac{16D}{4095} + 4$	$D = \frac{4095}{16} (A - 4)$

For example, if you have measured the signal as 10mA, you can use the formula to determine the digital value (D) that will be stored in the V-memory location that contains the data.

$$D = \frac{4095}{16} (A - 4)$$

$$D = \frac{4095}{16} (10\text{mA} - 4)$$

$$D = (255.93) (6) \quad D = 1536$$

5

Range	If you know the digital value	If you know the analog signal level
0 to 20mA	$A = \frac{20D}{4095}$	$D = \frac{4095}{20} (A)$

This example shows the result for the 0 to 20mA range.

$$D = \frac{4095}{20} (A)$$

$$D = \frac{4095}{20} (10\text{mA})$$

$$D = (204.75) (10) \quad D = 2047.5$$

Module Resolution

Analog Data Bits

The first twelve bits represent the analog data in binary format.

Bit	Value	Bit	Value
0	1	6	64
1	2	7	128
2	4	8	256
3	8	9	512
4	16	10	1024
5	32	11	2048

MSB												LSB											
[] [] [] [] [] [] [] [] [] [] [] []												[] [] [] [] [] [] [] [] [] [] [] []											
												1 1 9 8 7 6 5 4 3 2 1 0											
												1 0											

[] = data bits

5

Resolution Details

Since the module has 12-bit resolution, the analog signal is converted from 4096 counts ranging from 0–4095 (212). For example, a 4mA signal would be 0 and 20mA signal would be 4095. This is equivalent to a binary value of 0000 0000 0000 to 1111 1111 1111, or 000 to FFF hexadecimal. The diagrams below show how this relates to the two signal ranges.

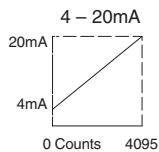

$$\text{Resolution} = \frac{H - L}{4095}$$

H = high limit of the signal range

L = low limit of the signal range

$$16\text{mA} / 4095 = 3.907\mu\text{A per count}$$

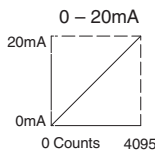

$$20\text{mA} / 4095 = 4.884\mu\text{A per count}$$

Analog Input Ladder Logic Filter

PID Loops / Filtering:

Please refer to the “PID Loop Operation” chapter in the DL06 or DL05 User Manual for information on the built-in PV filter (DL05/06) and the ladder logic filter (DL06 only) shown below. A filter must be used to smooth the analog input value when auto tuning PID loops to prevent giving a false indication of loop characteristics.

Smoothing the Input Signal (DL06 only):

The filter logic can also be used in the same way to smooth the analog input signal to help stabilize PID loop operation or to stabilize the analog input signal value for use with an operator interface display, etc.



Warning: The built-in and logic filters are not intended to smooth or filter noise generated by improper field device wiring or grounding. Small amounts of electrical noise can cause the input signal to bounce considerably. Proper field device wiring and grounding must be done before attempting to use the filters to smooth the analog input signal.

Using Binary Data Format

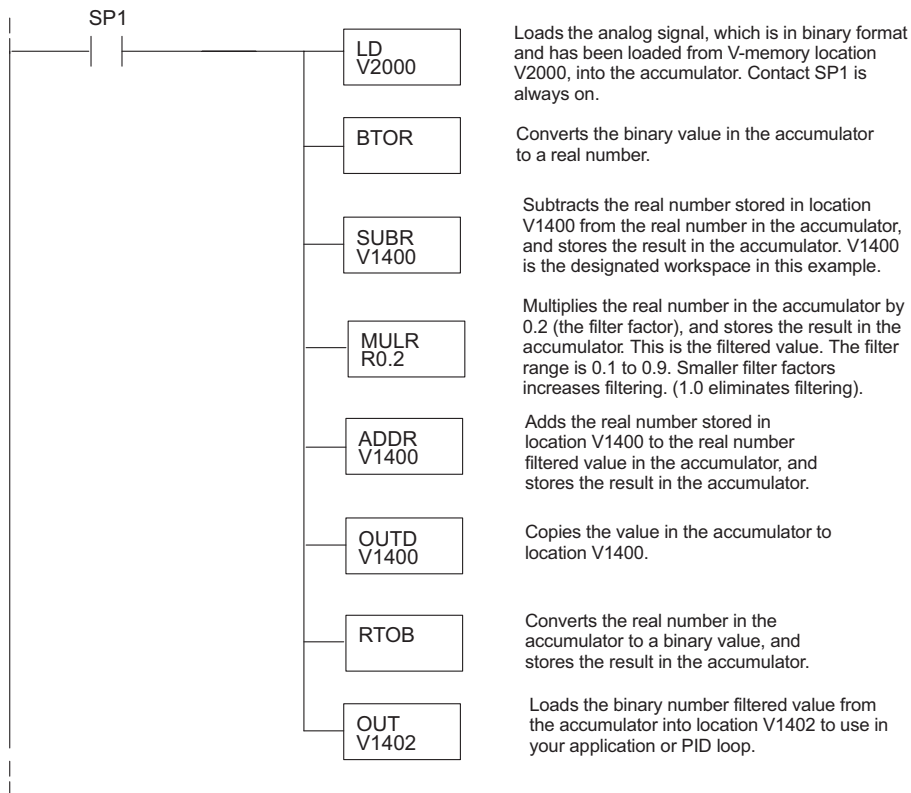



NOTE: Be careful not to do a multiple number conversion on a value. For example, if you are using the pointer method in BCD format to get the analog value, it must be converted to binary (BIN) as shown below. If you are using the pointer method in Binary format, the conversion to binary (BIN) instruction is not needed.

Using BCD Data Format

