

**High-speed** 30 Hz/10 Hz (with Dipswitch selected)  
200 Hz/1 kHz (with Set-up Mode selected)

A preset counter that aggregates counts with functions that provide a large, two-color LED for display that is easy-to-read in a small DIN48x48 body. Dual output of predicted output and preset output can be set with settings for predicted output.



### Merits

#### ● Large, easy-to-see display

A large LED for display with character height of 12 mm (4 digits) and 10 mm (6 digits) is used in a small DIN48x48 body.

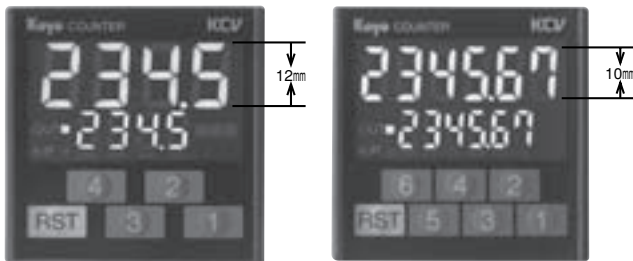

#### ● Easy operation

Setting and changing of preset values with individual setting keys has the feel of digital switches.

#### ● User configurable digit number

User can configure the no. of digit.

#### ● Battery-less memory retention

EEPROM is used to retain values in memory, so there is no need for battery maintenance.

#### ● Removable terminals

Maintenance has been reduced via terminals that can be removed. After wiring, the terminal cover provides a safe surface for worry-free use.

#### ● Tamper proof

Key protection can be set for individual keys to prevent tampering.

#### ● Power source for a large-capacity sensor (AC P/S type only)

You can source the power for sensor from the built-in P/S 24VDC, 60mA.

#### ● Free power supply for the AC type

The operating AC voltage is wide as 85VAC~264VAC.

#### ● Various types of counts

[Prescaling]

- The input pulse can be converted to any values and displayed.

[Dual phase addition/subtraction by individual input]

- The counting range can be from positive to negative.

However, settings are in the positive range.

[Addition-Subtraction]

- Counts can be selected for positive or negative display.

#### ● Dual output with alarm output

Dual setting is possible with alarm output.

Alarm values are values prior to reaching preset values.

#### ● High-speed response with 10 kcps

The input response frequency for this class is a maximum of 10 kHz. Input operational speed can be adjusted to switch to 30, 200, 1 k, or 10 kHz.

#### ● IP65

Membrane is used to protect from operation with wet or dirty hands, A special cover is also provided as an option to enhance the protective structure.

#### ● Designed in compliance with CE and UL

## List of Models

Category	Model Number	Number of Digits	Source Voltage	Sensor Source Voltage DC24 V 60 mA
Preset counter	KCV-4S	4	AC	●
	KCV-4S-C		DC	
	KCV-6S	6	AC	●
	KCV-6S-C		DC	
Total counter	KCV-4T	4	AC	●
	KCV-4T-C		DC	
	KCV-6T	6	AC	●
	KCV-6T-C		DC	

AC:AC100~240V  
DC:DC12~24V



4-digit



6-digit

## Model number system

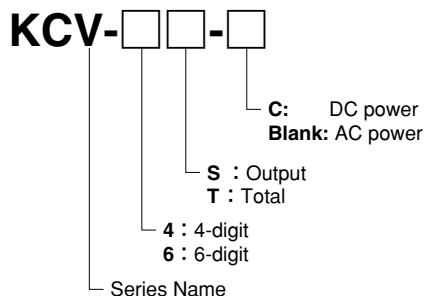

Accessories: Installation Frame

## General Specifications

Item	Specification	
	AC power	DC power
Source voltage	AC100~240V	DC12~24V
Permitted power fluctuation	AC85~264V	DC10~26.4V
Power consumption	approx. 11 VA	approx. 4 W
Sensor power	DC24 V (20-28V) 60 mA (Max. 10%p-p ripple)	
Memory Backup upon Power Failure	EEPROM (Writing Up to 100,000 times) Memory Duration 10 years	
Ambient temperature	-10~50°C	
Storage temperature	-20-70°C (with no freezing)	
Ambient humidity	35-85%RH (with no dewing)	
Withstand voltage	AC 2kV for one minute (for AC input, 0 V, and relay interconnection) (for DC input, 0 V, and relay interconnection)	
Vibration resistance	Durable	Displacement amplitude 0.5 mm Frequency 10-55 Hz along three axes
	No malfunction	Displacement amplitude 0.35 mm Frequency 10-55 Hz along three axes
Impact resistance	Durable	490 m/s <sup>2</sup> 11 ms along three axes
	No malfunction	98 m/s <sup>2</sup> 11 ms along three axes
Noise resistance	AC power ±1.5 kV between terminals (pulse width 1 of μs and rise time 1 of ns)	DC power ±1.0 kV between terminals (pulse width 1 of μs and rise time 1 of ns)
Protective structure	IP65 (front panel only)	
Weight	Approx. 150 g	Approx. 110 g
Terminals	Conforming wiring	0.25~1.65mm <sup>2</sup>
	Conforming crimped contact	R1.25-3
	Permitted torque	0.5Nm

## Performance Specifications

Item	Preset Counter	Total Counter
Category	Addition and Subtraction Preset Counter	Addition and Subtraction Total Counter
Setting	Single with alarm output	_____
Number of digits	4 or 6 digits	4 or 6 digits
Display (LED character height)	4-digit: 12 mm (count)/7 mm (preset) 6-digit: 10 mm (count)/7 mm (preset)	
Counting range	4-digit : -999-9999 6-digit:-99999-999999	
Setting range	4-digit : 0-9999 6-digit: 0-999999	_____
Input	Operational speed: 30/200/1 k/10 kHz switching	
	Input resistance: positive logic 15 k $\Omega$ Negative logic 3.3 k $\Omega$ (AC power)/1.8 k $\Omega$ (DC power)	
	Input voltage: "L" 0-3 V "H" 7-30 V	
Disabled count input	Responded in less than 100 $\mu$ s	
External reset	Max. signal amplitude 5 ms	
Automatic reset	Responded in less than 100 $\mu$ s	
Manual reset	Responded in less than 0.1 s	
Input gate duration during power failure	20~500ms	
Input gate duration during power recovery	50~500ms	
Output	DC output: NPN open collector output 24 V 100 mA Withstand pressure 35 V residual voltage less than 1.5 V	_____
	Relay output: 1 transformer relay AC220V 2A (resistance load)	_____
Output mode	One-shot/ Hold/Match	
Output duration	10-9990 ms every 10 ms	
Prescaling	0.001-99.999 (6-digit)/0.001-9.999 (4-digit)	
Decimal point	Lamp for arbitrary places available	
Key protection	Setting of arbitrary keys possible	Setting of reset keys possible
Installation	Exclusively for embedding (terminal block connection)	

•Prescaling is for 1x values.

## I/O Specifications

Count input	Input speed	30Hz/200Hz/1kHz/10kHz		
	Input resistance	Positive logic 15 k $\Omega$ Negative logic 3.3 k $\Omega$ (AC power)/1.8 k $\Omega$ (DC power)		
	Input voltage	L : 0~3V H : 7~30V		
Disabled count input	Input response	On delay: 0.1 ms Off delay: 0.1 ms		
	Input resistance	Positive logic 15 k $\Omega$ Negative logic 3.3 k $\Omega$ (AC power)/1.8 k $\Omega$ (DC power)		
	Input voltage	L : 0~3V H : 7~30V		
External reset input	Input response	On delay: 0.1 ms Off delay: 0.1 ms		
	Input resistance	Positive logic 15 k $\Omega$ Negative logic 3.3 k $\Omega$ (AC power)/1.8 k $\Omega$ (DC power)		
	Input voltage	L : 0~3V H : 7~30V		
Transistor output	Withstand voltage	Less than 35 V		
	Current	Less than 100 mA		
	Residual voltage	Less than 2 V		
Relay output	Capacity	AC220V 2A (resistance load)	AC220V 0.5A ( $\cos \phi = 0.4$ )	DC30V 0.5A (L/R=7ms)
	Lifetime	more than 100,000 uses	more than 200,000 uses	more than 200,000 uses

KCV

KCN-A

KCX

KCM

## Output modes

Mode	Count	Output
Hold	Continuous	Hold
One-shot	Reset	One -shot * 10-9990 ms
Match	Continuous	Match

\* Can be set in milliseconds from 10 to 9990 ms (in Setup mode).

## Output mode diagrams

Hold output (continuous count)

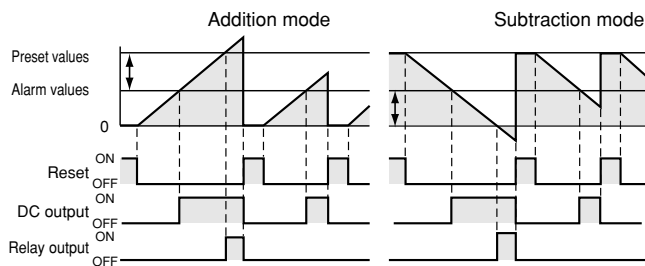

One-shot output (reset count)

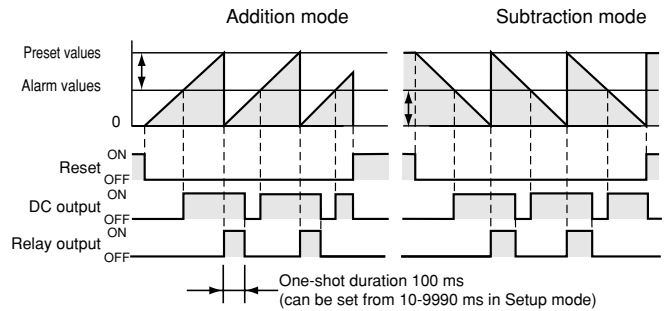

Matching mode (continuous count)

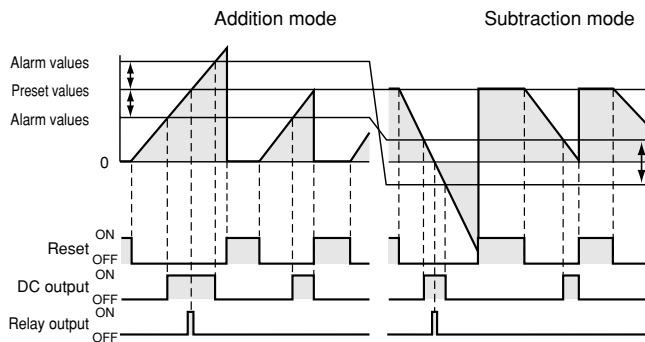

↑ : Alarm value setting  
↓ : Alarm value setting

When alarm values are set to 0, output operations for DC output will be the same as for relay output.

※When displaying alarm output (DC output), the output LED will blink on and off.

## Counting timing

Dual input mode

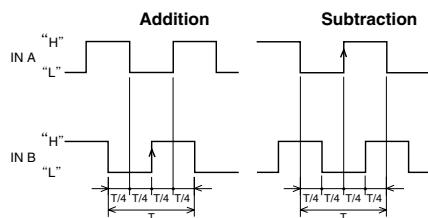

Input mode for addition or subtraction (during input of positive logic)

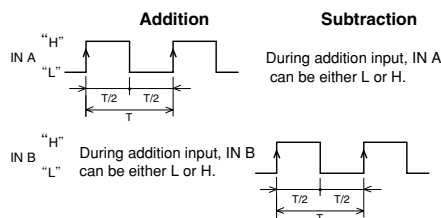

Input mode for addition or subtraction (during input of negative logic)

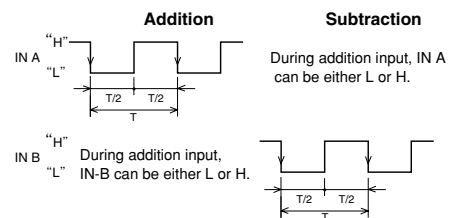

(Note)

With  $\uparrow$  or  $\downarrow$  the required counting speed is (CPS) =  $\frac{1}{T \text{ sec}}$

## Wiring Diagrams

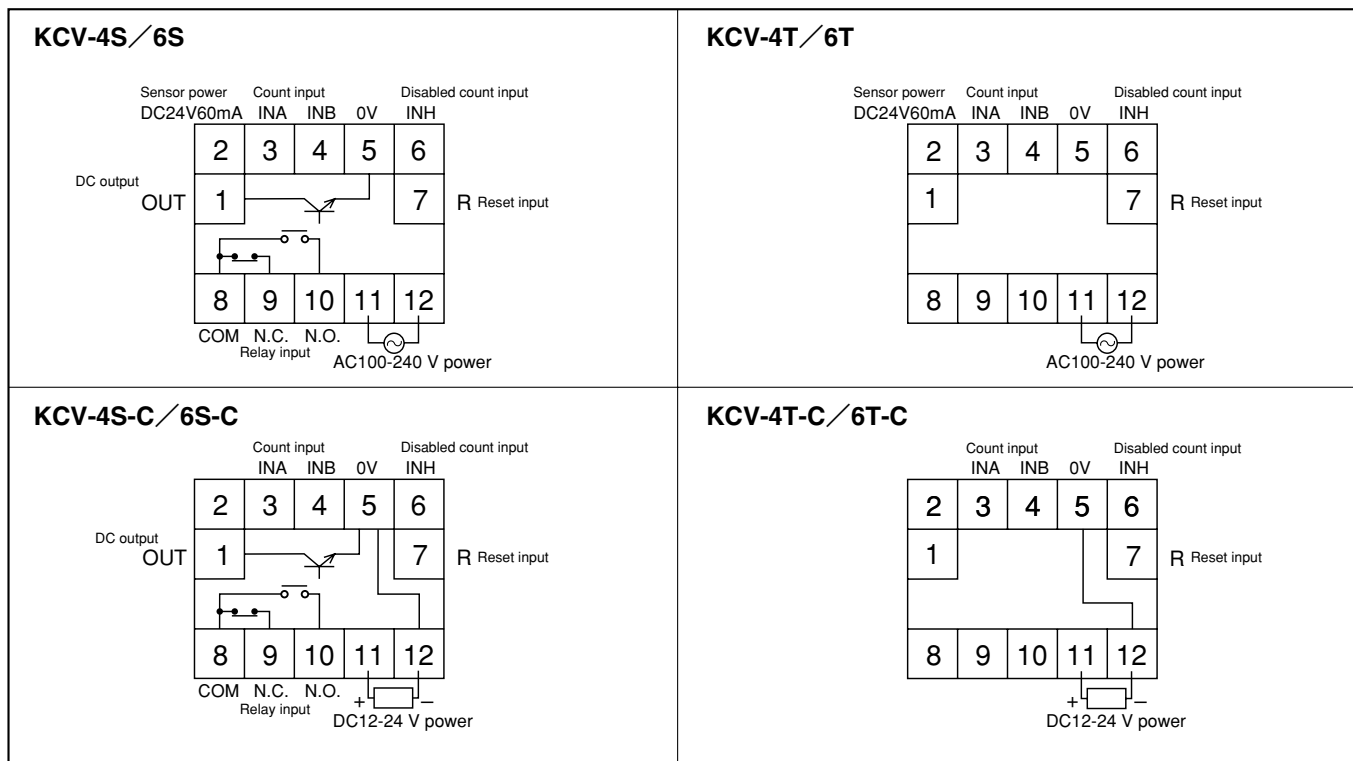

※Alarm output is used in combination with DC output (OUT terminal).

## I/O Circuit Diagrams

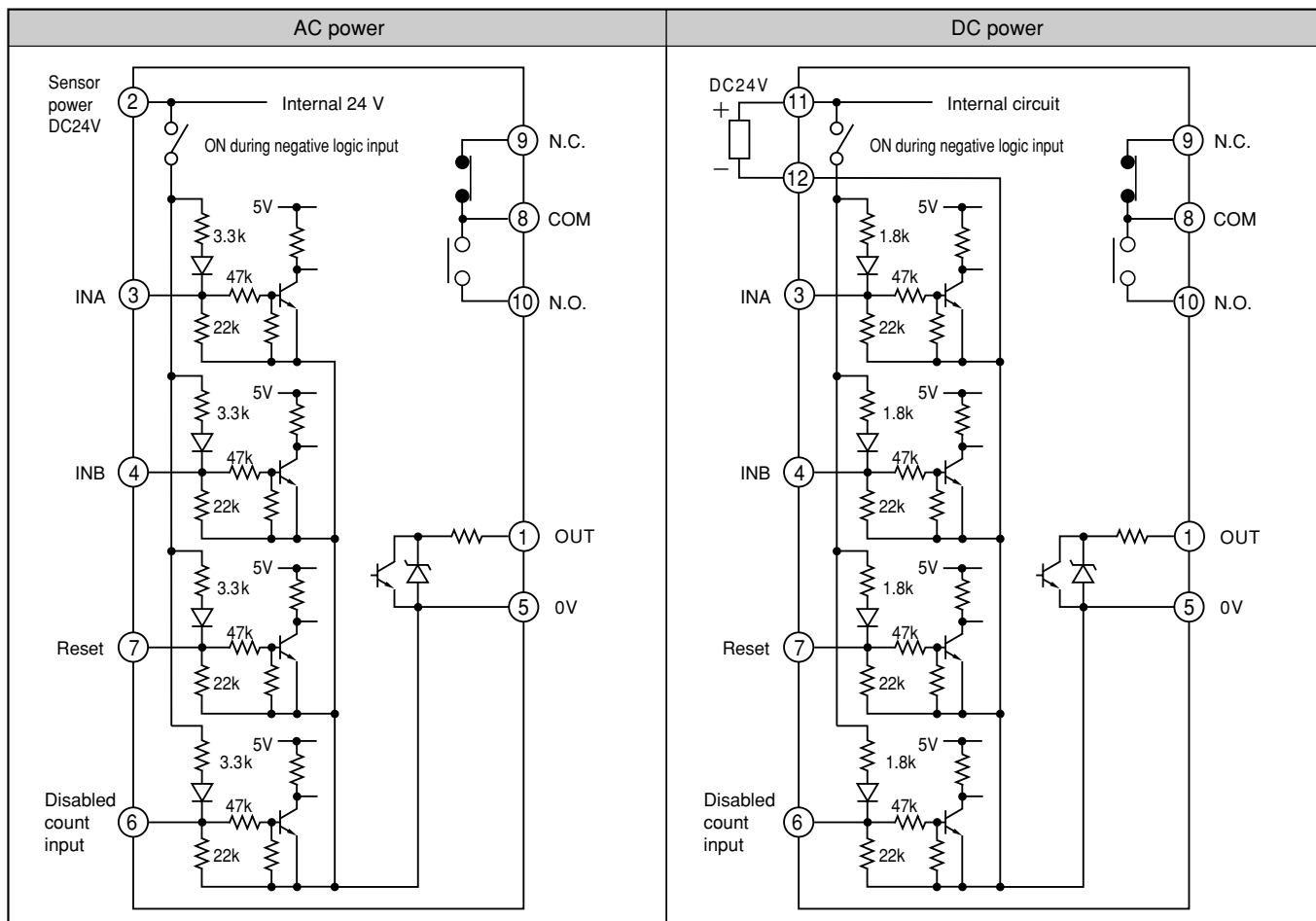

# Input Wiring Examples

<p><b>Proximity switch with NPN open collector output</b></p> <ul style="list-style-type: none"> <li>● Input logic: Negative logic: (no-volt input)(nE5)</li> <li>● Input mode: Input for addition or subtraction (Dip switch 2 ON)</li> </ul> <p>Recommended proximity switch: <b>APS□-□-N/E</b></p>	<p><b>Proximity switch with voltage output or PNP open collector output</b></p> <ul style="list-style-type: none"> <li>● Input logic: Positive logic: (voltage input)(Po5)</li> <li>● Input mode: Input for addition or subtraction (Dip switch 2 ON)</li> </ul> <p>Recommended proximity switch: <b>APS□-□-E2</b></p>
<p><b>DC 2-wire proximity switch</b></p> <ul style="list-style-type: none"> <li>● Input logic: Negative logic: (no-volt input)(nE5)</li> <li>● Input mode: Input for addition or subtraction (Dip switch 2 ON)</li> </ul> <p>Recommended proximity switch: <b>APS□-□-Z</b></p> <p>●With the DC type, please supply source voltage above 20 V.</p>	<p><b>Rotary encoder</b></p> <ul style="list-style-type: none"> <li>● Input logic: Arranged with encoder output and set as positive or negative logic</li> <li>● Input mode: Dual input (Dip switch 2 OFF)</li> </ul> <p>Recommended rotary encoder: <b>TRD-J□-RZ/S</b> <b>TRD-N□-RZ/S</b></p>
<p><b>Switch or relay</b></p>	
<ul style="list-style-type: none"> <li>● Input logic: Negative logic: (no voltage input)(nE5)</li> <li>● Input mode: Input for addition or subtraction (Dip switch 2 OFF)</li> <li>● Operational speed: 30 Hz (Dip switch 1 ON)</li> </ul> <p>●Input flow is heavy, so this connection is recommended.</p>	<ul style="list-style-type: none"> <li>● Input logic: Positive logic: (voltage input)(Po5)</li> <li>● Input mode: Input for addition or subtraction (Dip switch 2 ON)</li> <li>● Operational speed: 30 Hz (Dip switch 1 ON)</li> </ul>

※ There is no DC power source. Use a separate external power source.

# Output Wiring Examples

<p><b>NPN open collector output</b></p>	<p><b>Relay output</b></p>
---	----------------------------

## Front Panel Layout and Description

### ■ Panel guide

**① Output (red)**

- Operating mode  
Lit when output is ON.  
Blinks when alarm output is ON.

**② Key protection (red)**

- Operating mode  
Blinks when key protection is ON (only when the key is ON).
- Setup Mode  
Displays key protection settings.

**③ Count value (red)**

- Operating mode  
Displays count values.
- Setup mode  
Displays setting contents.

**④ Preset values (green)**

- Operating mode  
Displays preset values.
- Setup mode  
Displays set items.

**⑤ Digit keys**

- Operating mode  
Allows changes in preset values  
※ After changing preset values, total key input is ineffective for about one second. Preset values then take effect.
- Setup mode  
Allows to configure the setups.

**⑥ RST key**

- Operating mode  
Allows count values to be reset (0 for Addition and preset values for Subtraction).
- Setup mode  
Allows selection of set items.

● The Total Counter has several lamps that differ with respect to the Preset Counter:

- ① Output : None
- ② Key protection : None other than for display in compliance with (RST) key.
- ④ Preset values : Not displayed in Operating mode.
- ⑤ Digit keys : Not effective in Operating mode.

### ■ Key strokes

#### 1. Changing preset values

Press a digit key once to increase the corresponding digit by one:

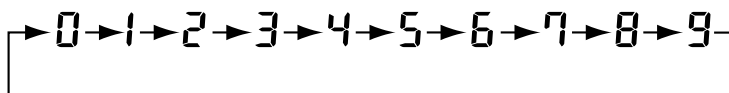

After removing your finder from the key, the settings will be verified after about one second.

#### 2. Resetting the count

Press the (RST) key to reset the currently displayed count. The count is reset within 0.1 second after the key is pressed. For example, the current count 0010 is reset to 0 for Addition. It is reset to the preset value for Subtraction.

#### 3. Protecting the keys

Turning the Dip switch ON disables the reset and digit keys. If disabled keys are pressed, the LED for the corresponding key will blink. If Key protection is selected to disable keys in Setup mode, Dip switch 6 will come ON. At factory setup, Key protection in Setup mode is completely disabled, so just turning Dip switch 6 ON will disable all keys.

Example: When the counter is preset to "123"

- 1 Press the 1 key and the display changes to 124
- 2 Press the 2 key and the display changes to 134
- 3 Press the 3 key and the display changes to 234

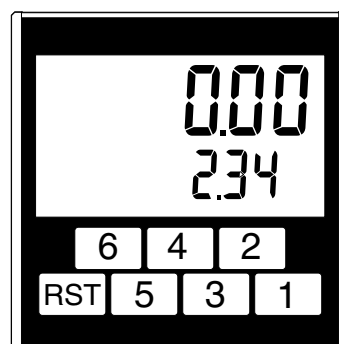

## Configure dip switches

- Use the dip switch on the top of the counter to configure various parameters and operation mode.
- Configure dip switches with power off. Operation with power up will have no effect.
- When dip switches are re-configured, you must press the Reset key in operating mode to reset the count values.

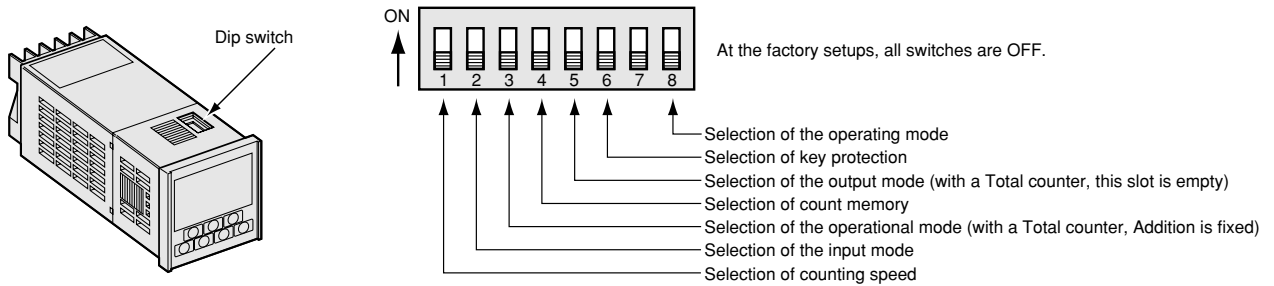

### Counting speed

The counting speed is selected with Dip switch 1.

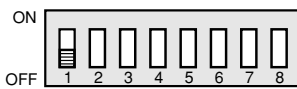

Counting speed	SW1
30Hz	ON
10kHz	OFF

※ Factory setup

### Input mode

The input mode is selected with Dip switch 2.

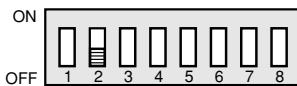

Input mode	SW2
Input for Addition or Subtraction	ON
Dual input	OFF

※ Factory setup

### Operational mode

The operational mode is selected with Dip switch 3.



Operational mode	SW3
Addition	ON
Subtraction	OFF

※ Factory setup

### Counting memory

The counting memory is selected with Dip switch 4.



Counting memory	SW4
Memory upon power failure	ON
Power source reset	OFF

※ Factory setup

### Output mode

The output mode is selected with Dip switch 5. Match output can be selected in Setup mode.

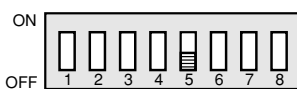

Output mode	SW5
Hold output	ON
One-shot output	OFF

※ Factory setup

### Key protection

With Dip switch 6, [Do not protect keys] can be selected to take effect for keys set in Setup mode using [Protect keys]. Setting for keys to protect can be performed in Setup mode. At the factory setup, [Do not protect keys] is set.



Key protection	SW6
Settings in Setup mode take effect	ON
Do not	OFF

※ Factory setup

### Operating mode

The operating mode is selected with Dip switch 8.

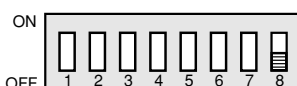

Operating mode	SW8
Setup mode	ON
Run mode	OFF

※ Factory setup

※ Dip switch 7 is not used.

## Setup mode

Settings that cannot be selected with dip switches can be set in Setup mode.

### Items that can be configured in Setup Mode

- (1) Counting speed—200/ 1 kHz, Dip switch 1
- (2) Input logic — Positive or negative logic
- (3) Output mode — Match output, Dip switch 5
- (4) Output duration—Duration of One-shot output can be set from 10-9990 ms (in 10-ms increments)
- (5) Prescaling — 4-digit: 0.001-9.999  
6-digit: 0.001-99.999
- (6) Prescaling factor — The scaling factor can be set for values used in prescaling.  
1x  
10x  
100x  
1000x
- (7) Number of digits — The number of counter digits for display can be set.  
4-digit: 1-4 digits  
6-digit: 1-6 digits
- (8) Decimal place — An arbitrary digit can be set for display of the decimal point.
- (9) Predicted output — Offset values can be set with respect to preset values.  
4-digit: 0-9999  
6-digit: 0-999999
- (10) Resetting key protection — Setting to disable the reset key can be performed.
- (11) Protecting digit keys — Setting to disable an arbitrary digit key can be performed.

※With a Total Counter, items 3, 4, 7, 9, 10, and 11 are skipped.

### 1. Switching Between Setup mode and Run mode

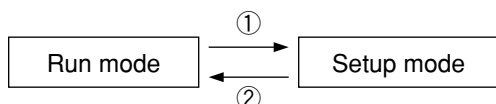

- ① Setting Dip switch 8 to ON and turning on the power will start the Setup mode.
- ② Setting Dip switch 8 to OFF and turning on the power will start the Run mode.

### 2. Operations in Setup mode

In Setup mode, the count can be initialized using the menu as follows:

\* Represents factory setup.

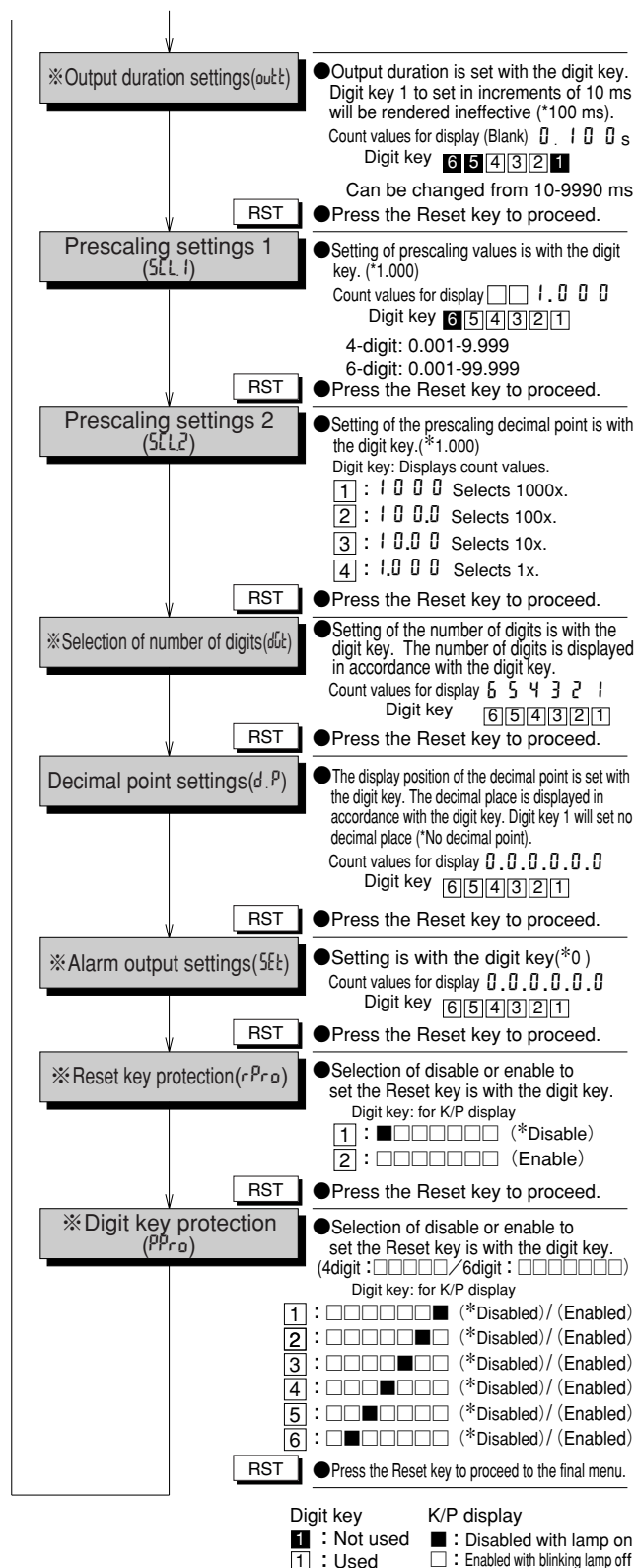
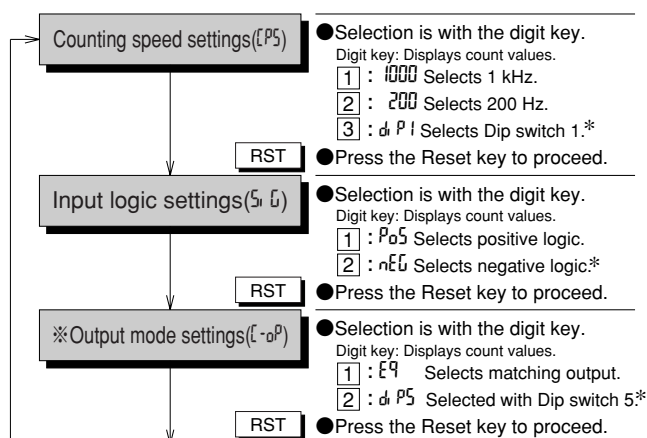

- The number of digits selected for setting of digits will render effective the settings for the decimal place, alarm output, and key protection that follow. Only the selected number of digits is set.
- With the Total Counter, items marked with an \* are skipped.
- When changing the setting of the number of digits selected, the decimal point will be removed, the alarm output will be set to 0, and preset values will automatically be changed to 5.
- After changing the default settings in Setup mode, press the Reset key in Run mode and reset count values.

## Operational Example (for KCV-6S)

### Run mode

#### Changing preset values

1. Change the preset value from 120 to 240

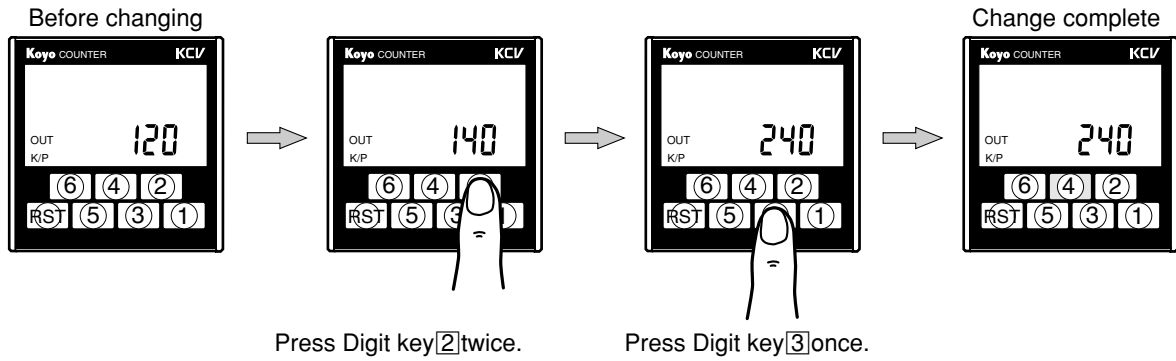

2. The preset value will be 240, and operations will continue with the altered value. Preset values will take effect about 1 second after being changed.

### Positioning application example with encoder

Positioning of a conveyor can be done in increments of 0.1 mm. It sets the Alarm in 20mm prior to the preset value to stop the conveyor in accurate position.

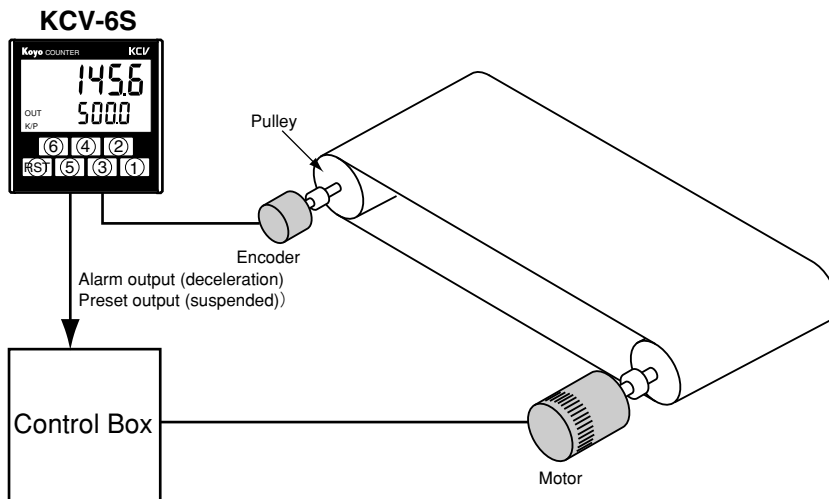

- Pulley diameter : 15 dia
- Encoder pulse count : 1000P/R

Set item	Set item
Counting speed	10kHz※
Input logic	Negative logic※
Output logic	One-shot※
Output duration	100ms※
Prescaling	0.047
Scale factor	10
No. of digits	6※
Decimal point	Between 1st and 2nd digit
Alarm output	20.0

※Represents factory setup.

#### 1. Prescale calculation

$$\begin{aligned}
 \text{Prescale} &= \frac{\pi \times \text{pulley diameter (mm)}}{\text{encoder pulse count}} \\
 &= \frac{3.1416 \times 15}{1000} \\
 &= 0.047\text{-mm pulse}
 \end{aligned}$$

## 2. Switching to Setup mode

Turn Dip switch 8 ON and then turn power ON (Dip switches 1-7 are OFF).

## 3. Changing setting contents

① The setting screen for **Counting speed** is first displayed.

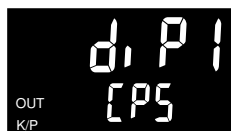

These values are initial values.

Press the (RST) key to proceed.

② The setting screen for **Input logic** is displayed.



These values are initial values.

Press the (RST) key to proceed.

③ The setting screen for **Output mode** is displayed.



These values are initial values.

Press the (RST) key to proceed.

④ The setting screen for **Output duration** is displayed.



These values are initial values.

Press the (RST) key to proceed.

⑤ The setting screen for **Prescaling settings 1** is displayed.



Set prescaling to 0.047.

Press the 4 key 9 times.

Press the 2 key 4 times.

Press the 1 key 7 times, and 0.047 will appear.



Press the (RST) key to proceed.

⑥ The setting screen for **Prescaling settings 2** is displayed.



Set the scaling factor to 10.

Press the (3) key 1 time and 10 will appear.



Press the (RST) key to proceed.

⑦ The setting screen for the **Number of digits** is displayed.

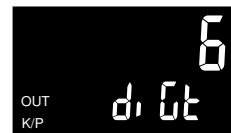

These values are initial values.

Press the (RST) key to proceed.

⑧ The setting screen for the **Decimal point** is displayed.



Display the decimal point between the first and second digit.

Press the 2 key and the decimal point will be displayed between the first and second digit.



Press the (RST) key to proceed.

⑨ The setting screen for **Alarm output** is displayed.



Set the alarm output to 20.

Press the (3) key twice and 20.0 will appear.



Press the (RST) key to proceed.

Setting is complete after this step.

## 4. Switching to Run mode

Turn the power OFF after completing setting in Setup mode and turn Dip switch 8 OFF (Run mode) (When power is OFF, all the setups in Setup mode are saved in the memory).

## 5. Starting Run mode

Be sure to turn power ON after changing the setups in Setup mode and press the (RST) key to reset the count values.

KCV

KCN-A

KCX

KCM

## Error Codes

### Common Errors

Error	Error type	Error details	Corrective Action
E21	Memory data error	Preset values and Setup mode items have changed.	Press the (RST) key to eliminate the error display. The count value will be set to 5000, and the Setup mode contents will be set to settings used at factory setup.
Decimal point blinking	Counter Overflow Error	Count values have exceeded the display range.	Error display will be cleared by the " (RST) " key or when the count value return to the count range. In the counter, correct calculation is in a range from - 2147483.648 to 2147483.647.
Decimal point blinking Negative display	Counter Underflow Error	Count values are below the display range.	

●Counter Overflow Error

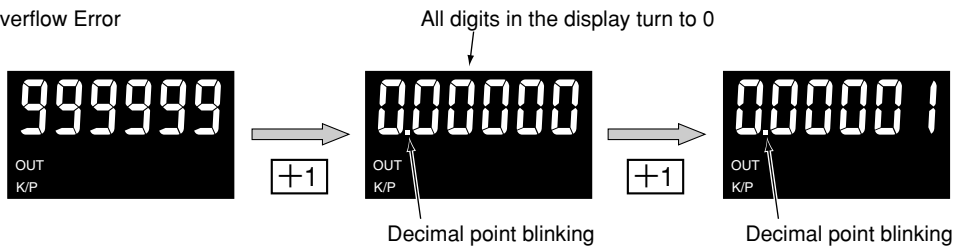

●Counter Underflow Error

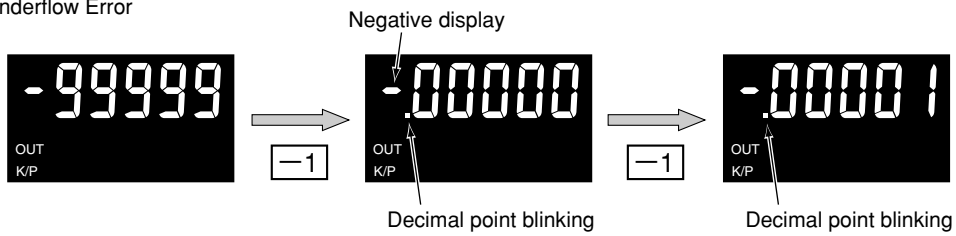

## Option

Option	Model Number	Details
Rubber packing	<b>KC-48P</b>	Prevents water from entering the control panel by installing this between the installation panel and KCV.
Front cover	<b>KC-48C</b>	Protects the front panel from dirt and the like. Material: Soft silicone rubber Key operation can be performed with the front cover as-is.

## Precautions

### ●Precautions for Use

- (1) With the DC power source, the 0-V terminal ⑫ and the input common 0-V terminal ⑤ are internally short-circuited.
- (2) Apply the rated voltage in one instant, not by gradually raising the voltage.
- (3) Always use negative input logic to set the DC 2-wire proximity switch.
- (4) During counting, changes to preset values will take effect about one second after key input of the change. In subtraction mode, key input takes effect when the count is reset valid preset value will be saved in the memory at loss of power.
- (5) It is recommended to use a sheet included in the package to keep the setups for the future maintenance.
- (6) Use in the following environments should be avoided:
  - A location where the ambient temperature is above 50°C or below 10°C.
  - A location where the ambient humidity is above 85% or abrupt temperature changes may cause condensation.
  - A location with dust, iron fillings, corrosive gasses, or the like.
  - A location exposed to direct sunlight.
  - A location with significant vibrations or impact.
- (7) When conducting testing of insulation withstand voltage, insulation resistance, or the like, remove the KCV counter from control box.

### ●Precautions for Wiring

- Keep the wires away from power line.
- With regard to use in locations where extensive noise is generated, keep the KCV counter and wires away from the noise source to the extent possible.
- Empty terminals are not to be used as relay terminals.
- For connection, use of crimped contacts is recommended. When wiring the 1 and 7 terminals, do not install fork-shaped crimped contacts at an angle. Use a round crimped contact for angled installation.

Fork-shaped crimped contacts

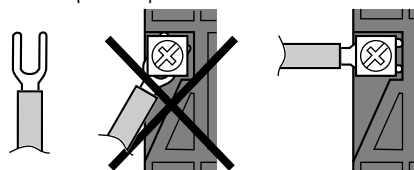

For angled installation, connection with the contact is insufficient. Like in the illustration above, install the contact perpendicular to the horizontal.

Round crimped contact

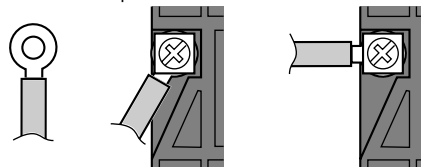

## Installation and Removal of the Main Body

### ●Installation

- ① Insert the main body through the panel installation port.

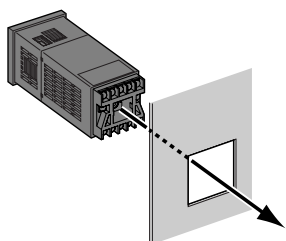

- ② From the rear, mount the installation frame.

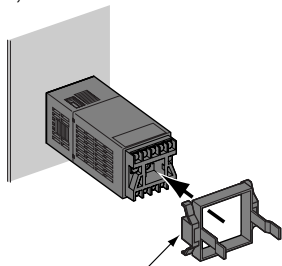

Installation frame: Can be installed vertically or horizontally.

### ●Removal

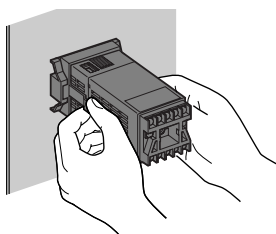

- ① Holding the tabs, spread them 2-3 mm.
- ② While keeping the tabs spread, pull the device towards you.

### ●Installation of the Terminal Block and Terminal Cover

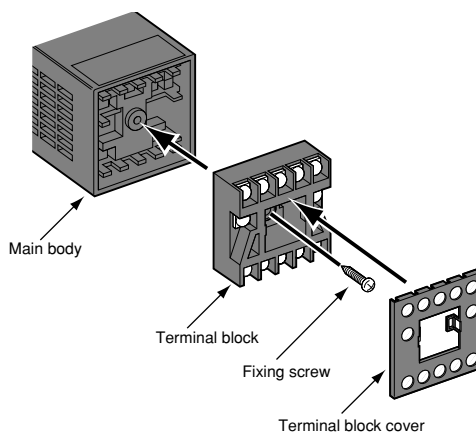

- Do not use a screw other than the one used to fix the terminal block during shipping.
- Maintain a permitted torque of 0.3 Nm.
- Install the terminal block after wiring is complete.

## External Dimensions

(in mm)

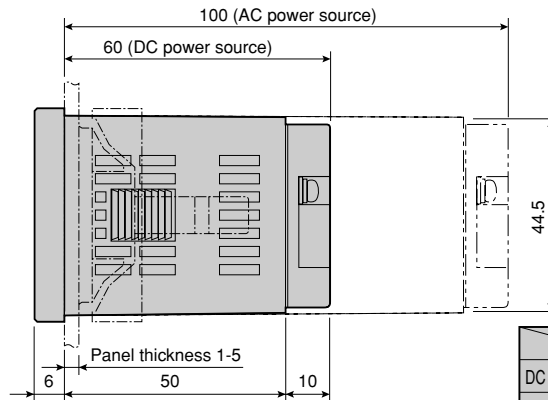
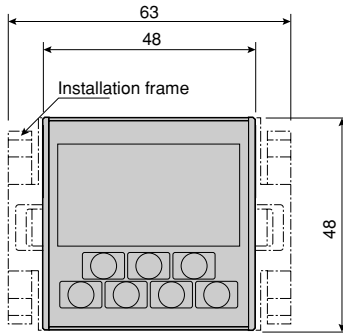

	Depth
DC power source	66mm
AC power source	106mm

## Detailed Diagram of the Terminal Block Boring Dimensions for Installation

1. When the installation handle is horizontal

2. When the installation handle is vertical

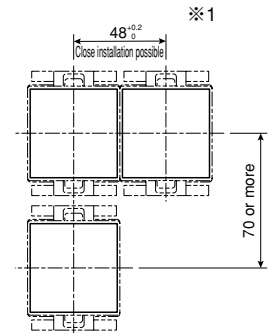
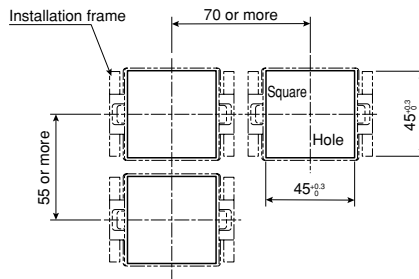
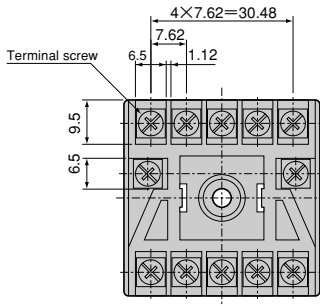

Complying wiring : 0.25~1.65mm<sup>2</sup>  
 Complying crimped contact: R1.25-3  
 Permitted torque : 0.5Nm

※ When aligning the front cover (KC48C and KC48P), line dimensions should be more than 55 mm.